

# Archgard

FIREPLACES



FIREPLACES

## 42 DVT40N

Fireplace Dimensions :

42" (1066mm) W x 35-1/2" (889mm) H x 18" (457mm) D\*

### SPECIFICATIONS

Input Rating	
Natural Gas	27,000-40,000 BTU/hr 7.9-11.7 kW/hr
Propane	30,000-36,000 BTU/hr 9.1-10.7 kW/hr
Efficiencies	
Steady State	82%
Afue Efficiency	73%
P4	56.50%

### FIREBACK OPTIONS



**42-BRPL-QCG /**  
Brick Panel,  
Québec City Grey



**42-BRPL-QCR /**  
Brick Panel,  
Québec City Red

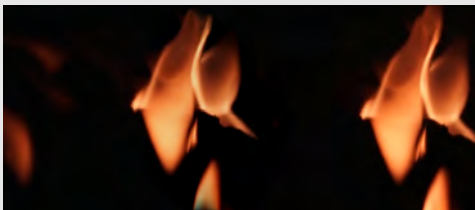

**42-BRPL-RG /**  
Eternal Flame Reflective  
Ceramic Glass



With Archgard gas fireplaces, the flame can be seen throughout the entire firebox. The combination of our innovative panoramic wall to wall burner design and unique High Definition logsets allow us to give you the look and feel of a traditional wood fire complete with glowing embers. Complete your install with any of our stylish decorative accessories to become the highlight of your home's decor.

For more information, pictures, and videos visit [archgard.com](http://archgard.com)

\* See the manual for more information.

\*\* All units come standard with barrier screens which attach to the door with very little effort.



Take control of your home heating and save on energy costs without compromising comfort with Archgard's zone heating. Leave the furnace off and enjoy the heat when and where you need it most with your 42 DVT40N.

**Large Viewing area** – With its immense viewing area and Archgard's panoramic wall to wall burner design, the 42 DVT40N is the eye catching and inviting centerpiece you have been seeking for your home.

Fireplace name: 42 DVT40N  
Louver kit: 42- LKB (Louver Kit Black)  
Firebrick option: 42- BRPL-QCG (Quebec City Grey)



## 72 DVT30N

Fireplace Dimensions :  
38"(965mm) W x 38"(965mm) H x 16-1/4"(412mm) D\*

### SPECIFICATIONS

Input Rating	
Natural Gas	20,100-30,000 BTU/hr 5.9-8.8 kW/hr
Propane	23,000-30,000 BTU/hr 6.7-8.8 kW/hr
Efficiencies	
Steady State	86%
Afue Efficiency	74%
P4	62.75%

### FIREBACK OPTIONS



**72-BRPL-QCG /**  
Brick Panel,  
Québec City Grey



**72-BRPL-QCR /**  
Brick Panel,  
Québec City Red

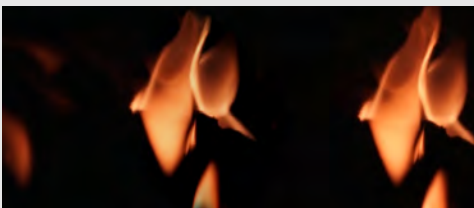

**72-BRPL-RG /**  
Eternal Flame Reflective  
Ceramic Glass



Relax and let your Archgard fireplace warm your home on those cold nights when you need it the most. The German engineered silent direct drive heat distribution fans will provide the warmth you need faster and farther than natural convection.

For more information, pictures, and videos visit [www.archgard.com](http://www.archgard.com)

\* See the manual for more information.

\*\* All units come standard with barrier screens which attach to the door with very little effort.



Customize your fireplace by adding decorative accessories from our range of designer fronts and louvers. Choose from three optional distinct firebox linings: Modeled after brickwork found in La Citadelle de Québec, the Quebec City Grey Brick provides a clean and alternative look while adding some old-world charm. The Quebec City Red Brick maintains that old-world charm while bringing a more traditional look. The robust Eternal Flame Reflective Ceramic Glass liner outlasts the typical porcelain and enhances your fireplace experience by adding an endless flame to the backdrop of your fireplace.

Fireplace name: 72 DVT30N  
Surround: 72 DAHVBL (Door, Arch, Hemlock Valley, Black)  
Firebrick option: 72-BRPL-QCG (Québec City Grey)



## 3400 DVTR20N\*\*

Fireplace Dimensions :  
34-5/8" (863mm) W x 30" (762mm) H x 15-3/4" (381 mm) D\*

### SPECIFICATIONS

Input Rating	
Natural Gas	13,000-20,000 BTU/hr 3.8-5.8 kW/hr
Propane	15,000-20,000 BTU/hr 4.4-5.8 kW/hr
Efficiencies	
Steady State	86%
Afue Efficiency	78%
P4	61.94%

### FIREBACK OPTIONS



**3400-BRPL-QCG /**  
Brick Panel,  
Québec City Grey



**3400-BRPL-QCR /**  
Brick Panel,  
Québec City Red

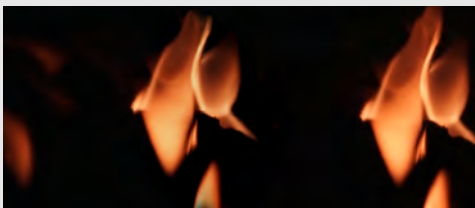

**3400-BRPL-RG /**  
Eternal Flame Reflective  
Ceramic Glass



Quality, Design, and Dependability are at the core of every Archgard fireplace. The affordable 3400 DVTR20N is no exception.

This 20,000 BTU heater rated direct vent gas fireplace will fit any budget. Customize your fireplace by adding optional variable speed heat distribution fans, Quebec City Grey or Quebec City Red brick panels, or the robust Eternal Flame Reflective Ceramic Glass.

For more information, pictures, and videos visit [archgard.com](http://archgard.com)

\* See the manual for more information.

\*\* All fireplaces come standard with barrier screens which attach to the door with very little effort.

+ Top or rear vent.



#### Easy to use

The 3400 DVTR20N is an installer's dream. Easy to install with simple top or rear flex venting on a shallow 16" firebox and easy to maintain with tool free removal of the ultra-durable ceramic glass door. The breathtaking fire presented by the 3400 DVTR20N coupled with simple installation leaves only one problem: how many rooms should you complete?

#### Household Refinement

Whether building a new home or improving your existing home, the 3400 DVTR20N will exceed your expectations and become the focal point of any room.

Fireplace name: 3400-DVTR20N  
Surround: 3400 FIFAB ( Forged Iron Front, Arch, Black)  
Firebrick option: 3400-BRPL-QCG (Québec City Grey)



# TECHNICAL SPECIFICATIONS

	42 DVT40N	72 DVT30N	3400 DVTR20N
Natural Gas Input Rating	27,000-40,000 BTU/hr 7.9-11.7 kW/hr	20,100-30,000 BTU/hr 5.9-8.8 kW/hr	13,000-20,000 BTU/hr 3.8-5.8 kW/hr
Propane Input Rating	30,000-36,500 BTU/hr 9.1-10.7 kW/hr	23,000-30,000 BTU/hr 6.7-8.18 kW/hr	15,000-20,000 BTU/hr 4.4-5.8 kW/hr
Efficiencies			
Steady State	82%	86%	86%
AFUE Efficiency	73%	74%	78%
P4	56.50%	62.75%	61.94%
Minimum Fireplace Opening			
Framing dimensions	35-3/4" H x 42" W x 17-1/2" D	38" H x 38" W x 16-1/4" D	31" H x 34-3/4" W x 16" D
Viewing Area	H 14.5" x W 26.75"	H 15.5" x W 29"	H 16.5" x W 32.4"
	4 x 7" flex or approved 6 5/8" rigid		
Vent Exit location on unit	Top exit	Top exit	Top or rear exit
Clearance to Combustibles			
Mantle Clearance	46" from bottom of unit to bottom of 12" mantle	45" from bottom of unit to bottom of 6" mantle	35" from bottom of unit to bottom of 6" mantle
Standard Features			
Ceramic Glass	Included	Included	Included
Burner Type	Wall to wall steel pan with Elite Lifetime Warranty		
Firebox Construction	Welded/Rivet and Gasket silicone free		
Warranty options	Elite Limited Lifetime	Elite Limited Lifetime	Elite Limited Lifetime
Fan Kit	Included	Included	Optional
Propane conversion kit	Optional	Optional	Optional

Tested and Approved to Noth America Standards ANSI Z21.88B-2014/CSA 2.33-2014 and CAN/ CGA-2.17-M91

## LOUVERS OPTIONS



Louver Kit,  
Brushed Nickel

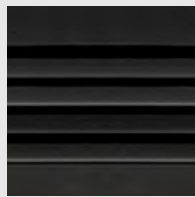

Louver Kit,  
Black

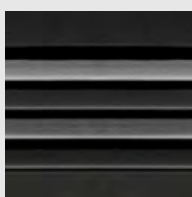

Louver Kit,  
Alternating Brushed  
Nickel and Black

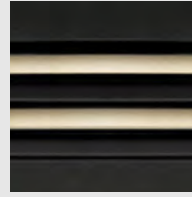

Louver Kit,  
Alternating Gold tone  
and Black



TECHNICAL DIMENSIONS

TOP VIEW

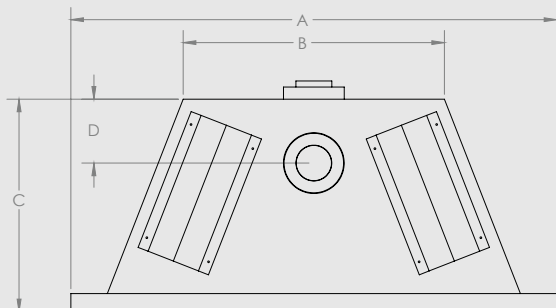

SIDE VIEW

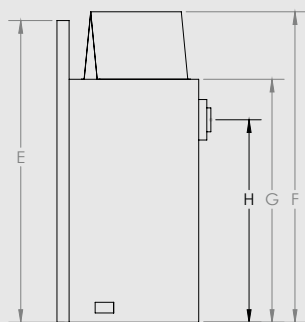

CORNER FRAMING

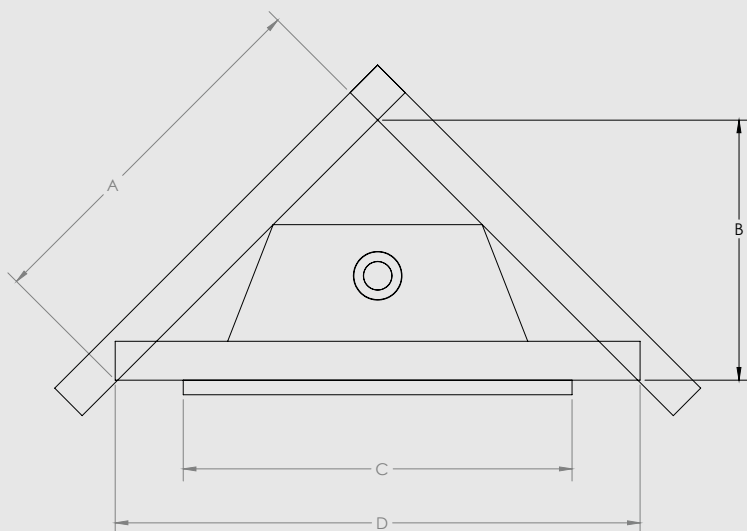

42 DVT40N (TOP VENT ONLY)

A	B	C	D
44"	23-1/4"	18"	6-1/2"
1118mm	584mm	457mm	164mm
E	F	G	H
34"	35-1/2"	32-1/2"	N/A
864mm	889mm	813mm	N/A

72 DVT30N (TOP VENT ONLY)

A	B	C	D
38"	21-1/2"	16-1/4"	6-1/2"
965mm	545mm	412mm	164mm
E	F	G	H
31"	38"	29-3/4"	N/A
787mm	965mm	756mm	N/A

3400 DVTR20N (TOP & REAR VENT)

A	B	C	D
34-5/8"	23-1/2"	15-3/4"	6-3/4"
864mm	584mm	381mm	152mm
E	F	G	H
29"	30"	27-1/2"	20-1/2"
737mm	762mm	686mm	508mm

42 DVT40N

A	B	C	D
41"	29"	42"	58"
1041mm	737mm	1067mm	1473mm

72 DVT30N

A	B	C	D
39-1/8"	27-5/8"	38"	55-1/4"
994mm	686mm	965mm	1403mm

3400 DVTR20N

A	B	C	D
*39-1/2"	28"	34-3/4"	46.75"
991mm	711mm	864mm	1187mm

\*This measurement allows for 6" sidewall clearance on sides of unit (required).

FRONTS & DOORS



Forged Iron Front Square  
FIFSB / FIFSP



Forged Iron Front Arch  
FIFAB / FIFAP



Wrought Iron Front Arch  
72-WIFASDB / WIFASDP



Door Arch  
DAHVB / 72-DAHVBL

FOR MODEL 42

38" h x 44" w

**B** **P**

~38" h x 44" w x 34 7/8" to shoulder

**B** **P**

~34 5/8" h x 39 1/8" w x 32" to shoulder

Hemlock Valley **B**

FOR MODEL 72

36" h x 42" w

**B** **P**

36" h x 42" w x 32 7/8" to shoulder

Single door **B** **P**

~35" h x 39-3/4" w x 32-1/4" to shoulder

Hemlock Valley **B**

FOR MODEL 3400

~33 1/2" h x 40 1/2" w

**B**

~33 1/2" h x 40 1/2" w x 30 1/2" to shoulder

**B** **P**

FRONTS & DOORS



Forged Iron Front Square Bow  
72-FIFSBOW2DB\* / 72-FIFSBOW2DP\*

FOR MODEL 72

\*35-1/2" h x 42" w

\*Bow, Double door

**B** **P**

LOUVER KITS & FILLIGREES

Louver Kit

Filligree Inset

FOR MODEL 42

**N**\* **B**  
Alternating **B** **N**\*  
Alternating **B** **Gt**\*\*

Logo Design **B** **N**\* **G**\*\*

FOR MODEL 72

**N**\* **B**  
Alternating **B** **N**\*  
Alternating **B** **Gt**\*\*

Logo Design **B** **N**\* **G**\*\*

FOR MODEL 3400

**N**\* **B**  
Alternating **B** **N**\*  
Alternating **B** **Gt**\*\*

Logo Design **B** **N**\* **G**\*\*

\*Brushed Nickel / \*\*24K Plated

**N** Nickel **G** Gold **Gt** Gold tone **B** Black **P** Pewter

For more information, pictures, and videos visit [archgard.com](http://archgard.com)

\* See the manual for more information.

\*\* All units come standard with barrier screens which attach to the door with very little effort.

High Definition logs



Forged Iron Door



Brick panel,  
Québec City Grey



Brick panel,  
Québec City Red



Archgard  
FIREPLACES

[archgard.com](http://archgard.com)



Barrier screen

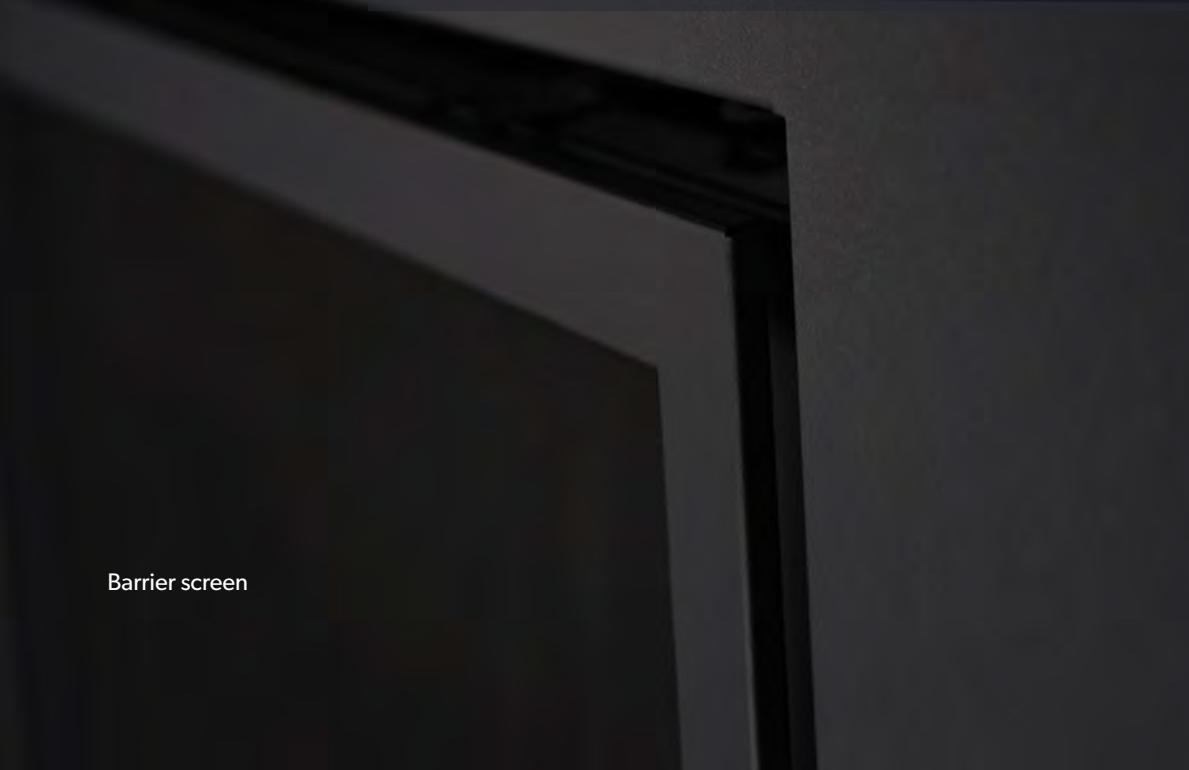

Forged Iron Door



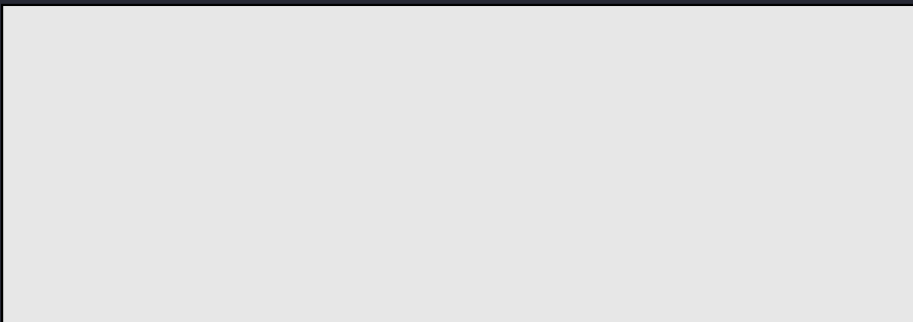

Archgard Fireplace Products  
7116 Beatty Drive Mission BC V2V 6B4  
[archgard.com](http://archgard.com)